

OHS Certification Australia

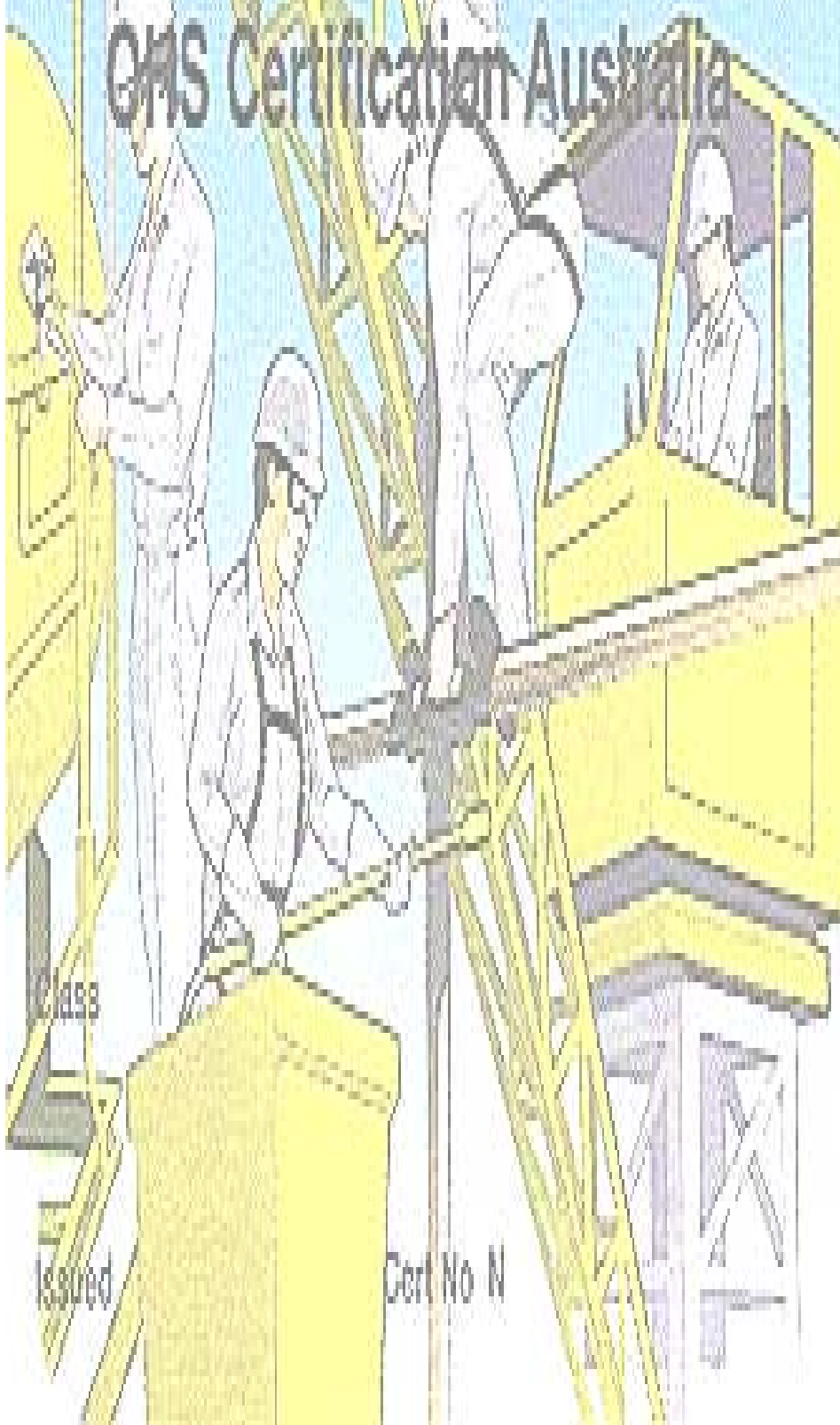

# Forklift Truck

August 2000

**OHS Certificates of Competency  
National Assessment Instrument**

# **Loadshifting Equipment**

## **Forklift Truck**

### **Assessment**

*Part 1 Performance*

*Part 2 Oral/Written*

**AUGUST 2000**

# Contents

---

	<i>Page</i>
Assessor Guidelines – General.....	1
Assessor Guidelines – Specific (performance) .....	4
Practical Course Layout .....	6
Part one – Performance Assessment .....	7
Assessor Guidelines – Specific (Oral/Written) .....	12
Part two – Oral/Written Assessment .....	13
Attachment A .....	23
Attachment B .....	24
Oral/Written Assessment Answers.....	25
Assessment Summary .....	30

# ASSESSOR GUIDELINES GENERAL

---

## 1. Introduction

### 1.1 Scope

These general guidelines apply to all the assessment instruments for the certificates of competency prescribed by the *National Guidelines for Occupational Health and Safety Competency Standards for the Operation of Loadshifting Equipment and Other Types of Specific Equipment*. [NOHSC: 7019]

Assessors should also be familiar with the publication *Assessment guidelines for National Occupational Health and Safety Certification Standard for users and operators of industrial equipment*.

### 1.2 Additional Guidelines

Guidelines that provide additional specific information to certificate assessors are also included in each assessment instrument. Included, where appropriate, are specific instructions on the usefulness of training records (such as logbooks) and other certificates with overlapping competencies.

### 1.3 Evidence of Competence

Evidence of competence is established in a number of ways. The methods used in the following instruments involve:

- Assessment of practical performance
- Written and/or oral answers to questions on underpinning knowledge.

## 2. Preparing for the Assessment

### 2.1 Study the Instruments

You need to read the assessment instruments and guidelines carefully before beginning an assessment.

### 2.2 Confirm Appointments

Prior to an assessment, you need to confirm the date, time and location of the assessment with the applicant and any other relevant people.

### 2.3 Equipment Availability

The availability of equipment, materials and a suitable working area must be organised and confirmed, prior to the assessment.

### 2.4 Workplace Factors

Because procedures and processes vary greatly between workplaces, it is important for assessors to plan their approaches to meet the requirements of the individual workplace.

Make sure you take the timeframe into account when planning the assessment and also make applicants aware of any time limits.

### 2.5 Selecting Questions

Questions for the written/oral assessment should be randomly selected, either by hand or using a computer system, if applicable.

## 3. Conducting the Assessment

### 3.1 Provide an Explanation

Begin by explaining clearly to the applicant what is required of them. Check that the applicant has provided (or has been provided with) the necessary tools and equipment.

### 3.2 Practical Performance

Complete the practical performance checklist, as the applicant works through the required tasks. Wherever possible, this should be done in a normal working environment.

Do not ask the applicant questions while he/she is performing a task, as this can be distracting, and may affect the time taken to complete the assessment.

If, at any time, the applicant is endangering themselves or others, stop the assessment immediately. This indicates that the applicant is not yet competent and may require further training, before being reassessed.

Assessments should also be stopped, if equipment or property is likely to be damaged.

### 3.3 Knowledge

The oral/written assessment determines the applicant's understanding of knowledge. The model answers provided with the oral/written assessment instruments are not necessarily exhaustive. Use your own judgement when scoring alternative answers.

### 3.4 Recording Responses

A box accompanies each item and question on the assessment forms you use. Assessors must complete every box as follows:

CORRECT PERFORMANCE/ANSWER

X NOT YET ACHIEVED

NA NOT APPLICABLE

If a box is marked incorrectly, cross out the mistake, mark the correct response alongside, and initial the change.

## 4. Determining Competencies

### 4.1 Assessment Summary

A specific assessment summary is given for each certificate class. This is to be filled in and signed by the assessor and counter signed by the applicant.

Notice of Satisfactory Assessment  
The original and duplicate are given to the applicant. The applicant provides

the original to the certifying authority. The triplicate is retained by the assessor.

### 4.2 Competency Requirements

In order for you to deem an applicant competent, he or she must have completed each section of the assessment to the standard required. You should note any time constraints when arriving at your decision.

The standard required for each instrument is specified in the specific guidelines and/or on the summary page at the end of each instrument.

In the case of a re-assessment, the assessor can decide to apply the whole or only that part of the assessment not yet achieved.

### 4.3 Additional Comments

Where an applicant fails to meet the standard of competence, you should add a written comment on the Assessment Summary, which briefly explains the problem.

Advice to the applicant, on the appropriate remedial action should also be included. This will also assist the certificate assessor, in the event that the applicant undergoes future reassessment.

Likewise, if an applicant demonstrates outstanding or remarkable performance, this should be noted.

### 4.4 Further Investigation

As a certificate assessor, it is your role to determine whether or not an applicant has achieved the standard necessary for the certifying authority to be able to grant a certificate of competency.

Whenever you are unsure of the applicant's performance or knowledge, ask additional questions, and obtain additional evidence, before making your final decision.

**National Guidelines for OHS Competency Standards**

# **Loadshifting Equipment**

## **Forklift Truck**

*Part 1*  
*Performance Assessment*

**August 2000**

## ASSESSOR GUIDELINES- SPECIFIC (Performance)

**ASSESSMENT  
INSTRUMENT – SPECIFICATIONS**  
**This assessment of performance covers the  
load shifting elements of competence:  
1.1, 1.2, 1.3, 2.1, 3.1 and 3.2**

1. The assessment requires the applicant to transfer and shift loads following a sequence of:

### **Unit 1**

- a) pre-operational checks
- b) planning the work
- c) checking controls on equipment

### **Unit 2**

- d) shifting & stacking load
- e) loading & unloading

### **Unit 3**

- f) shutting down equipment
- g) securing the site

2. The performance assessment can be conducted at any location that facilitates proper assessment of the above mentioned competency elements.

3. **The following equipment and materials must be available during assessment:**

- a forklift truck in safe operating conditions which complies with the requirements of the relevant state legislation.
- low, medium and high level racks or stacks.
- a suitable load (see note 11)

4. **A full performance assessment can take up to 1 Hour to complete.**

Applicants will be advised by the Assessor what the acceptable time to complete the assessment is, based on the assessment course layout.

5. The applicant must undertake all performance criteria. An assessor must

Use his/her discretion in assessing competence under each criteria. The elements under each criteria must be marked with the appropriate tick, cross or n/a to indicate an applicant's competence level for that element.

**Assessors Note:** All performance criteria marked with a star ☆ are compulsory / critical. To determine a person's competence under each performance criteria, a prescribed number of elements are required to be demonstrated/answered under that criteria. The applicant must achieve the minimum specified number or more, of the performance elements to achieve competence for those criteria. To record the applicant's competence for the criteria a tick must be placed in the star.

7. Overall competence is achieved when competence in all units has been achieved.

**7. THE APPLICANT MUST UNDERTAKE ALL PERFORMANCE CRITERIA.**

**8. N/A - NOT APPLICABLE. N/A IS ONLY TO BE USED IN THE CASE OF A REASSESSMENT OR WHERE RPL HAS BEEN GRANTED TO THOSE CRITERIA.**

**9. IN CASES WHERE CRITERIA CANNOT BE PHYSICALLY PERFORMED FOR ANY REASON, OR THE FORKLIFT TRUCK DOES NOT HAVE THAT FEATURE; THE APPLICANT IS REQUIRED TO DEMONSTRATE HIS/HER UNDERSTANDING OF THESE CRITERIA BY SIMULATION OR BY ANSWERING RELEVANT QUESTIONS.**

10. **Unit 2 (Shift load, unload) must be carried out using a suitable load. It is recommended that the load used should be approximately 50% of the forklifts maximum capacity where practical, or of a suitable physical dimension e.g. 1 cubic metre to simulate a normal load.**

**AN EMPTY PALLET MUST NOT BE USED IN THE ASSESSMENT**

11. Side Shifters, if fitted, may be used during the practical exercise involving the chicane/obstacle course.
12. Assessors should consult with management of the workplace before proceeding with the assessment to ensure that the assessment will not disrupt normal workplace practices.
13. **Note: In Performance criteria 1.2.1, the assessor must place various hazards within the work area to enable the applicant to identify those hazards and then take the appropriate safeguarding measures.**
14. The applicant's competence in each unit is to be summarised on the Assessment Summary sheet found in the back of the instrument.
15. The assessment course design on page six is provided as an example of what can be done either in a simulated or work place environment. Consider the following in relation to course layout and test procedure:
- This may be done with the existing fittings or fixtures (such as the corners of the building, racks, columns etc.) and/or the use of drums or pallets, etc.
  - Dimensions would depend on the fork lift truck being used. The aim is to provide a course which will require skill to negotiate with a loaded forklift truck in forward and reverse, but not too difficult to be impractical.

- Go to start and carry out pre-operational checks.
- Pick up load at A drive forward and place load at B.
- Pick up load at B drive forward and place load at C.
- Pick up load at C drive forward through chicane (obstacle) and place load at D.
- Pick up load at D reverse through chicane (obstacle) place load at E - withdraw attachments and park forklift truck.

**INSTRUCTIONS TO APPLICANT:**

16. You may ask questions to ensure you understand the correct procedure before you begin and if necessary you may also seek clarification of the correct procedure during the assessment.
17. You will be asked some questions either during or after the assessment to establish the reasons for your decisions and actions. I may raise an arm as an indication for you to stop the activity to allow questioning.
18. The full practical assessment shall cover: -

**(Unit 1)**

- Pre operational check of the forklift truck
- Inspection of the work site. Identification of work site hazards and the selection of control measures.
- Start up check of forklift truck.

**(Unit 2)**

- Operation of forklift truck, including the movement of various loads, pick up and placement of loads from low, medium and high level racking.

**(Unit 3)**

- Correct shut down and parking procedure for forklift truck.

# EXAMPLE OF PRACTICAL ASSESSMENT COURSE LAYOUT

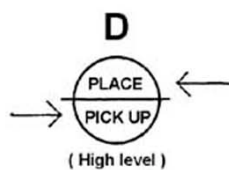
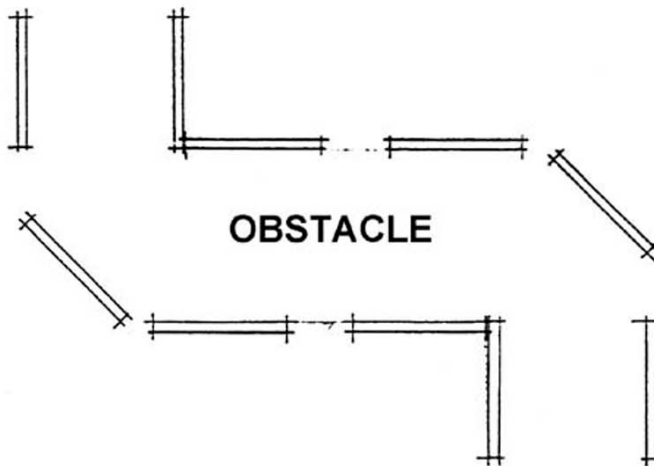
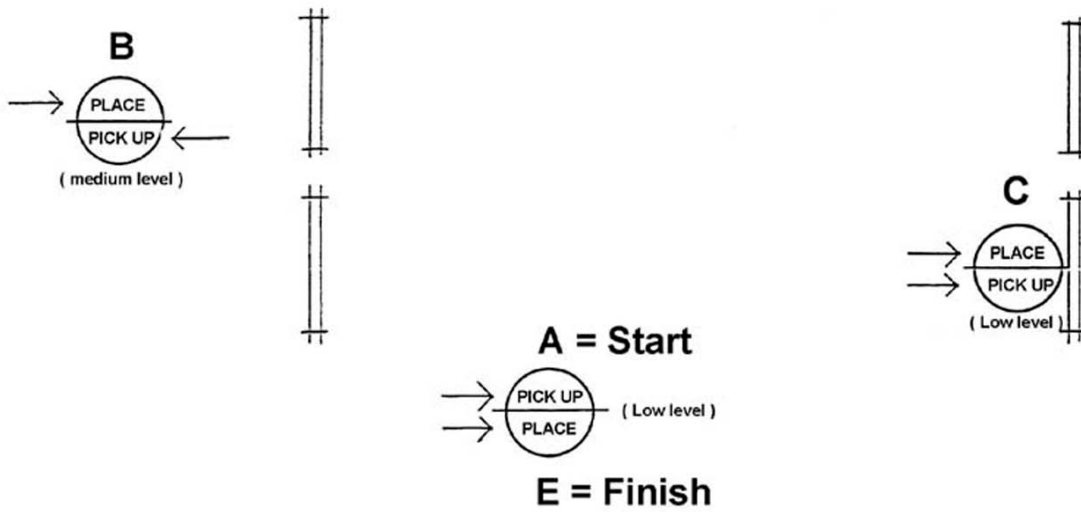

## NOTES

- 1  ARROW INDICATES DIRECTION OF APPROACH.
- 2 OBSTACLE SHALL BE NEGOTIATED C TO D TRAVELLING FORWARD.
- 3 OBSTACLE SHALL BE NEGOTIATED D TO E TRAVELLING IN REVERSE.

# UNIT - 1

## CONDUCT ROUTINE CHECKS

### Performance Criteria 1.1.1 and 1.1.2

#### 1. Conduct routine checks on forklift (at least 12 elements checked)



- Lift and tilt systems
- Mast assembly
- tyre condition, wheel nuts and pressure
- engine oil
- hydraulic oil level
- transmission oil
- battery security, water level and cleanliness
- brake fluid
- Coolant
- power steering
- air filter indicator (if diesel)
- Seat adjusted and secured
- Seat belt (condition and security)
- Mirrors adjusted, and clean
- Windscreen condition and clean
- Overhead guard (condition and security)
- Load Plate

- Load backrest (condition and security)
- Security of LPG gas cylinder, tank in date and condition of system
- Compliance plate for gas installation
- Condition and security of batteries
- Condition of fork arms or attachments
- Pins or other locking devices checked for security

### Performance Criteria 1.2.1, 1.2.2, 1.2.3 and 1.2.5

#### 2. Inspects site and plans work

#### All hazards are identified where applicable (at least 12 hazards identified)



- power lines
- doorways
- overhead service lines (inside and/or outside)
- bridges
- surrounding buildings
- obstructions
- other equipment in area
- personnel in area
- dangerous materials
- railway lines

- Other hazards unique to the workplace (where applicable)
- Applicant immediately removes hazards, or ensures hazards are eliminated by instigating appropriate action
- Applicant immediately removes hazards, or ensures hazards are eliminated by instigating appropriate safeguarding measures
- Before operating, applicant ensures that site personnel are made aware of forklift operation and any access restrictions for pedestrians
- Applicant is wearing suitable protective clothing and equipment and explains why it is important he/she is wearing this equipment
- Forklift truck type is suitable for load and height limitations. Applicant explains his/her reasons why the forklift truck would be suitable
- Attachments and fittings are appropriate for load type

- Checks lights,
- Checks warning devices
- Checks gauges
- Braking system whilst moving
- Steering system whilst mobile
- Operation of controls results in smooth and correct operation of selected function. All functions must be tested to the full extent of their movement.
- Checks underneath machine for any water or oil leaks
- Checks clear for travel before moving
- Applicant clearly explains what action he/she would take if any damage or defects were detected during the pre operational and start up checks

## UNIT 2 – SHIFT LOAD

### Performance Criteria 1.3.1, 1.3.2

#### 3. Conducts pre-operational start-up checks in accordance with manufacturer's specifications/ operating manual - (at least 9 actions/checks made)



- Mounts correctly
- Adjusts seat
- Fastens seat belt (if fitted)
- Demonstrates correct start up procedure

### Performance Criteria 2.1.1, 2.1.2, 2.1.4, 2.1.5 and 2.1.6

#### 4. Applicant operates forklift truck (at least 24 elements performed correctly)



- Assesses the weight of a load before lifting
- Follows and maintains agreed travel plan/path
- Ensures travel direction clear
- Operator keeps to the left in aisles or roadways for two way traffic

- Gives way to other traffic before moving off
- Maintains a safe distance from other vehicles
- Travels at safe speed
- No mishaps or near misses when operating
- Where forklift goes undetected by others, operator takes appropriate action by, either, stopping or slowing vehicle, sounding horn or flashing lights.
- Looks in direction of travel before the forklift truck moves.
- Does not travel with load until load is lowered to safe height.
- Travels in reverse if load obscures forward vision, and must constantly look in the direction of travel.
- No object in the path of forklift is hit or knocked over.
- Operator keeps all parts of the body within the forklift when travelling. However, when manoeuvring or positioning loads operator may lean out for a clearer view.
- Correct hydraulic controls are selected.
- Operation of controls is smooth.
- Whilst manoeuvring in a confined area the applicant shunts or repositions forklift truck to access the load.
- Attachment is correctly positioned relative to rack or stack before raising the load.
- Inserts attachments without touching or scraping the rack, stack or pallet.
- Load is correctly positioned relative to attachment before raising.
- Mast is vertical or on slight back tilt to stabilise the load when raising from racks or stacks.
- Forklift is moved clear of the racks or stacks, and the load lowered to correct travel height with operator checking for sufficient clearance before travelling.
- While travelling, the attachment or load is high enough to just clear any bumps or rises in the floor.
- Where fitted, fork arms must be below front axle height. With other fittings, bottom of load is at axle height and/or high enough to clear obstacles.
- During travel, the mast is tilted back slightly to ensure the load is laying towards the load backrest or carriage. The load must remain correctly positioned on the attachment.
- Travels at a safe speed and maintains safe control of forklift.
- The load is correctly positioned relative to the rack or stack before placing the load.
- The load is positioned squarely in racks or stacks when placing the load.
- Operator ensures the load being placed settles evenly on the rack or stack before the attachments are withdrawn.
- Attachment is withdrawn cleanly.

- Applicant explains correct use of the park brake when raising or lowering a load on an incline, as per manufacturer's recommendations.

- Refuelling sites

- Blind corners

## UNIT – 3

- No less than two metres from nearest rail track

### SHUT DOWN EQUIPMENT

- Removes keys

#### Performance Criteria 3.1.1, 3.1.2 and 3.1.3

#### 5. Shuts down equipment and secures site: (demonstrated at least 4 elements)

- Dismounts correctly

- Parks equipment in a suitable location away from danger areas

- Lowers fork arms/attachments to ground

- Appropriate gear, relevant to the forklift transmission type, is selected when parking vehicle.

- Applies parking brake

- Engine/power is turned off

- LPG gas cylinder valve shut off

- Batteries are connected to recharger unit

#### SECURE SITE:

#### Performance criteria 3.2.1

#### 6. Secures site: (completes at least 6 elements)

##### Parked clear of:

- Access ways

- Walkways

- Fire/emergency exits

- First-aid facilities

**National Guidelines for OHS Competency Standards**

# **Loadshifting Equipment**

**Forklift Truck**

***Part 2***  
***Oral/Written Assessment***

**August 2000**

## ASSESSOR GUIDELINES – SPECIFIC (Oral/Written)

### ASSESSMENT

#### INSTRUMENT – SPECIFICATIONS

This assessment of knowledge covers the load shifting elements of competence 1.1, 1.2, 1.3, 2.1, 3.1 and 3.2

1. A full oral/written assessment consists of 52 questions and can take up to 1.5 hours to complete.
2. To satisfy the requirements for competency the applicant must correctly answer (either in writing or orally) all critical questions as indicated by a star and a minimum of 75% of the non-critical questions from each unit.  
**Assessor note:** The assessment summary specifies the appropriate number of non-critical questions to be achieved.

**Unit 1 1.1 - Select 7 including 2 stars**

**1.2 - Select 25 including 18 stars**

**1.3 - Select 2**

**Unit 2 2.1 - Select 13 including 9 stars**

**Unit 3 3.1 - Select 5 including 1 star**

3. If the assessment is conducted orally the assessor must record the answers provided by the applicant.
4. An applicant who holds an Order Picking Forklift Truck Certificate does not require assessment in Unit-3.
5. The items marked with a star are of critical importance. Failing to get any of these correct means that competency has not been achieved.
6. Competence is achieved for a unit when the required number of questions for that unit have been correctly answered and ticked.

7. Overall competence is achieved when competence in all units has been achieved.

### NOT APPLICABLE - N/A.

**N/A IS NOT TO BE USED FOR ANY RANDOMLY SELECTED QUESTIONS OR FOR ANY CRITICAL QUESTIONS. N/A IS ONLY TO BE USED IN THE CASE OF A RE-ASSESSMENT OR WHERE RPL HAS BEEN GRANTED TO THAT QUESTION.**

### INSTRUCTIONS TO APPLICANT

There are some very important questions marked with a star that you must get right. I will indicate these questions to you.

If you are unsure about the meaning of a question or would like to say more about your answer, ask me about it during or after the assessment.

I will check your answers after you have finished and ask you to explain anything that is unclear.

The oral/written assessment should be completed within 1.5 hours.

**CONDUCTS ROUTINE CHECKS:**

**UNIT 1**

**Element 1.1 (select 7 including 2 with a star)**

1. You are required to inspect your forklift truck before use. Name at least four liquid levels that would form part of your inspection?

\_\_\_\_\_  
\_\_\_\_\_  
\_\_\_\_\_

2. You are required to inspect your forklift truck before use. Name at least four parts which would form part of your inspection?

\_\_\_\_\_  
\_\_\_\_\_  
\_\_\_\_\_

3. What precautions should be taken by the operator when a leak in the fuel system is suspected or detected?

\_\_\_\_\_  
\_\_\_\_\_  
\_\_\_\_\_

4. During your pre operational check a hydraulic leak is detected. What action would you take?

\_\_\_\_\_  
\_\_\_\_\_  
\_\_\_\_\_

5. During your pre operational check you notice the Data Plate is missing or unreadable. What action would you take?

\_\_\_\_\_  
\_\_\_\_\_  
\_\_\_\_\_

6. Under what circumstances could an operator make minor repairs, alterations or adjustments to a forklift truck?

\_\_\_\_\_  
\_\_\_\_\_  
\_\_\_\_\_

7. If you noticed a crack in the heel of a fork arm would you try and repair it yourself?

\_\_\_\_\_  
\_\_\_\_\_  
\_\_\_\_\_

8. A tyre is found to have low pressure. When would you attend to this problem?

\_\_\_\_\_  
\_\_\_\_\_  
\_\_\_\_\_

9. What important function does a load backrest (load guard) perform on a forklift truck?

\_\_\_\_\_  
\_\_\_\_\_  
\_\_\_\_\_

10. To protect the operator from falling objects, what should be provided on a forklift truck?

---

---

---

---

15. Why is it unsafe to turn a forklift truck when it is on a ramp or sloping surface? ★

---

---

---

---

**Element 1.2 (select 25 including the 18 with a star)**

11. Should a forklift truck be refuelled while the engine is running? Explain your answer. ★

---

---

---

---

16. When operating a forklift why is it dangerous to turn a corner with the load raised? ★

---

---

---

---

12. What direction must the load face when travelling up a ramp? ★

---

---

---

---

17. How should you drive a forklift truck across railway tracks?

---

---

---

---

13. When travelling up a ramp, why must the load face uphill?

---

---

---

---

18. When travelling, at what height should the load and fork arms be? ★

---

---

---

---

14. What direction must the load face when travelling down a ramp? ★

---

---

---

---

19. When travelling name two items / conditions that would influence your speed of travel.

---

---

---

---

20. A pallet contains an unbalanced load with one end heavier than the other. Which end should be against the heel of the fork arms? ☆

\_\_\_\_\_  
\_\_\_\_\_  
\_\_\_\_\_

21. What would you do if you noticed a badly damaged pallet supporting a load? □

\_\_\_\_\_  
\_\_\_\_\_  
\_\_\_\_\_

22. How should bagged goods be transported and stored? □

\_\_\_\_\_  
\_\_\_\_\_  
\_\_\_\_\_

23. What is the minimum distance you should keep your forklift truck and load away from domestic powerlines and high voltage transmission lines? ☆

\_\_\_\_\_  
\_\_\_\_\_  
\_\_\_\_\_

24. What would you do if you drove your forklift truck mast into powerlines? List three actions. □

\_\_\_\_\_  
\_\_\_\_\_  
\_\_\_\_\_

25. Why is it dangerous to use internal combustion engines in confined spaces? ☆

\_\_\_\_\_  
\_\_\_\_\_  
\_\_\_\_\_

26. What is the most suitable type of forklift truck to use in confined spaces? □

\_\_\_\_\_  
\_\_\_\_\_  
\_\_\_\_\_

27. Why must batteries be charged in a well ventilated area? □

\_\_\_\_\_  
\_\_\_\_\_  
\_\_\_\_\_

28. Why must you not smoke when charging or changing forklift truck batteries? ☆

\_\_\_\_\_  
\_\_\_\_\_  
\_\_\_\_\_

29. What type of forklift truck should be selected for working on rough or unstable terrain? □

\_\_\_\_\_  
\_\_\_\_\_  
\_\_\_\_\_

30. What is meant by “collapsed height” in relation to a forklift truck?

\_\_\_\_\_  
\_\_\_\_\_  
\_\_\_\_\_

36. Why is a work permit to operate a forklift truck necessary at some work sites?

\_\_\_\_\_  
\_\_\_\_\_  
\_\_\_\_\_

31. What is meant by “overall extended height” in relation to a forklift truck?

\_\_\_\_\_  
\_\_\_\_\_  
\_\_\_\_\_

37. May a load be carried by only one fork arm of the forklift truck? Explain your answer.

\_\_\_\_\_  
\_\_\_\_\_  
\_\_\_\_\_

32. When travelling with a large load that obscures your vision, what precautions would you take?

\_\_\_\_\_  
\_\_\_\_\_  
\_\_\_\_\_

38. Are you allowed to add additional counterweights to a forklift truck without referring to the forklift manufacturer? Explain your answer.

\_\_\_\_\_  
\_\_\_\_\_  
\_\_\_\_\_

33. What should be provided when a forklift truck is working over a roadway, footpath or areas open to the public?

\_\_\_\_\_  
\_\_\_\_\_  
\_\_\_\_\_

39. What precautions should the operator take when operating the forklift truck on wet or slippery surfaces?

\_\_\_\_\_  
\_\_\_\_\_  
\_\_\_\_\_

34. Name two safeguards to protect other personnel when loads are been moved by a forklift truck

\_\_\_\_\_  
\_\_\_\_\_  
\_\_\_\_\_

40. What checks must be made before using an attachment on a forklift truck?

\_\_\_\_\_  
\_\_\_\_\_  
\_\_\_\_\_

35. Why is “rear end” swing dangerous on forklift trucks fitted with rear end steering?

\_\_\_\_\_  
\_\_\_\_\_  
\_\_\_\_\_

41. If you are required to use an attachment that you are not familiar with, what should you do?

\_\_\_\_\_  
\_\_\_\_\_  
\_\_\_\_\_

42. Name three operating precautions that must be taken when using a jib attachment?

\_\_\_\_\_  
\_\_\_\_\_  
\_\_\_\_\_

43. Is it permissible to use the forward tilt when lifting loads with a jib attachment? Explain your answer.

\_\_\_\_\_  
\_\_\_\_\_  
\_\_\_\_\_  
\_\_\_\_\_

44. What must be marked at each hook position on a jib attachment?

\_\_\_\_\_  
\_\_\_\_\_  
\_\_\_\_\_  
\_\_\_\_\_

45. When operating a forklift fitted with a carpet spike, what precautions would you take?

\_\_\_\_\_  
\_\_\_\_\_  
\_\_\_\_\_  
\_\_\_\_\_

46. Why should a side-shift attachment be centralised before travelling with a load?

\_\_\_\_\_  
\_\_\_\_\_  
\_\_\_\_\_

47. When using a revolving attachment is it permissible to rotate the load while travelling? Explain your answer

\_\_\_\_\_  
\_\_\_\_\_  
\_\_\_\_\_

48. What should be used to carry drums with a forklift truck?

\_\_\_\_\_  
\_\_\_\_\_

49. What must a lifting ring and the slings attached to it have in common?

\_\_\_\_\_  
\_\_\_\_\_  
\_\_\_\_\_  
\_\_\_\_\_

50. Should a jib attachment, lifting hook be fixed or able to swivel?

\_\_\_\_\_  
\_\_\_\_\_  
\_\_\_\_\_

51. For what reason must you ensure that a jib attachment hook is centred directly over a load before lifting?

\_\_\_\_\_  
\_\_\_\_\_  
\_\_\_\_\_  
\_\_\_\_\_

52. When should slings be inspected?   
\_\_\_\_\_  
\_\_\_\_\_  
\_\_\_\_\_

53. When inspecting wire rope slings, list five defects that would render the sling unsafe to use?   
\_\_\_\_\_  
\_\_\_\_\_  
\_\_\_\_\_

54. How would you determine the working load limit (WLL) for synthetic webbing slings?   
\_\_\_\_\_  
\_\_\_\_\_  
\_\_\_\_\_

55. Why is it important to secure the pin in a shackle?   
\_\_\_\_\_  
\_\_\_\_\_  
\_\_\_\_\_

56. What percentage of wear in a shackle would make it unsafe to use?   
\_\_\_\_\_  
\_\_\_\_\_  
\_\_\_\_\_

57. How would you determine the Safe Working Load of a multi-leg chain sling?   
\_\_\_\_\_  
\_\_\_\_\_  
\_\_\_\_\_

58. Should a load be raised or lowered near or over people? Explain your answer.  ★  
\_\_\_\_\_  
\_\_\_\_\_  
\_\_\_\_\_

59. What must be provided on a fork lift truck to allow a passenger to be carried?   
\_\_\_\_\_  
\_\_\_\_\_  
\_\_\_\_\_

60. Is it permissible to carry passengers on the bare fork arms or load? Explain your answer.  ★  
\_\_\_\_\_  
\_\_\_\_\_  
\_\_\_\_\_

61. By what means can people be raised on a forklift truck?  ★  
\_\_\_\_\_  
\_\_\_\_\_  
\_\_\_\_\_

62. When using a Work Platform to lift people, what position must the travel controls be in, and in what position must the parking brake be?   
\_\_\_\_\_  
\_\_\_\_\_  
\_\_\_\_\_

63. Where must the operator of a forklift remain when a person is raised in a Work Platform?

\_\_\_\_\_  
\_\_\_\_\_  
\_\_\_\_\_

68. Why is tyre pressure, and condition for pneumatic types, important to the stability of a forklift truck?

\_\_\_\_\_  
\_\_\_\_\_  
\_\_\_\_\_

64. Is a stepladder or other device allowed to be used to gain extra height whilst working from a Work Platform? 

\_\_\_\_\_  
\_\_\_\_\_  
\_\_\_\_\_

## UNIT 2

### Element 2.1 (Select 13 including 9 with a star)

65. On an electric forklift what would you use to isolate the power supply in an emergency?

\_\_\_\_\_  
\_\_\_\_\_  
\_\_\_\_\_

69. Because of load length, two forklift trucks are used to handle the same load (simultaneous use). Name any three operating precautions that must be observed.

\_\_\_\_\_  
\_\_\_\_\_  
\_\_\_\_\_

### Element 1.3 (select 2)

66. Give reasons why pre-operational checks are necessary before operating a forklift truck.

\_\_\_\_\_  
\_\_\_\_\_  
\_\_\_\_\_

70. How would you establish the capacity and limitations of the forklift truck and equipment you are required to use?

\_\_\_\_\_  
\_\_\_\_\_  
\_\_\_\_\_

67. If any defects are found or detected what must you do?

\_\_\_\_\_  
\_\_\_\_\_  
\_\_\_\_\_

71. What is meant by the term "Rated Capacity" in relation to a forklift truck?

\_\_\_\_\_  
\_\_\_\_\_  
\_\_\_\_\_

72. What is meant by load centre distance? 

---

---

---

---

73. How does increasing the load centre affect the capacity of a forklift truck? 

---

---

---

---

74. How will a forklift truck be affected if the load is not hard against the heel of the fork arms? 

---

---

---

---

75. Where is the forward Point of Balance (fulcrum) for a forklift truck? 

---

---

---

---

76. Is all the weight behind the Point of Balance acting as a counter-weight? 

---

---

---

---

77. The forklift trucks in Attachment A are rated at 2000 kg at 600 mm load centre, which one is overloaded? 

---

---

---

78. A forklift truck in Attachment B is rated at 4500 kg at 600 mm load centre. Which of the loads are within the capacity of the forklift truck? 

---

---

---

79. Give two reasons why you check the weight of a load against the forklift truck specifications. 

---

---

---

80. How would you determine the weight of an unmarked load? 

---

---

---

81. What is the approximate mass (weight) of a 200 Litre (44 gallon) drum full of water? 

---

---

---

82. How many Kilograms are there in 1 Tonne?

\_\_\_\_\_

\_\_\_\_\_

\_\_\_\_\_

83. What things should be considered when tiering (stacking) loads on top of each other?

\_\_\_\_\_

\_\_\_\_\_

\_\_\_\_\_

84. When should forward tilt of the mast be used?

\_\_\_\_\_

\_\_\_\_\_

\_\_\_\_\_

85. A pallet appears to be unsafely loaded. What would you do before attempting to lift it?

\_\_\_\_\_

\_\_\_\_\_

\_\_\_\_\_

86. Name three operating conditions that may cause a forklift truck to tip over sideways? (lateral instability)

\_\_\_\_\_

\_\_\_\_\_

\_\_\_\_\_

87. Name three operating conditions that may cause a forklift truck to tip forward length- ways? (longitudinal instability)

\_\_\_\_\_

\_\_\_\_\_

\_\_\_\_\_

88. What should be provided for the gap between a truck and a loading dock before shifting a load?

\_\_\_\_\_

\_\_\_\_\_

\_\_\_\_\_

89. Which vehicles must you give right of way to during emergency situations?

\_\_\_\_\_

\_\_\_\_\_

\_\_\_\_\_

**UNIT- 3**  
**Element 3.1 (Select 5 including 1 with a star)**

90. Name three locations within the workplace where you would not park your forklift truck.

\_\_\_\_\_

\_\_\_\_\_

\_\_\_\_\_

91. Why would you not park your forklift in front of a doorway?

\_\_\_\_\_

\_\_\_\_\_

\_\_\_\_\_

92. If your forklift truck must be parked on an inclined surface, what precaution would you take?

---

---

---

---

97. What is the reason for removing the ignition key when leaving the forklift truck unattended?

---

---

---

---

93. When parking your forklift truck what must be done with the fork arms?

---

---

---

---

94. Why do you turn off the LPG fuel valve after parking and before leaving your forklift truck?

---

---

---

---

95. Give 3 reasons why post operational checks are carried out on a forklift?

---

---

---

---

96. Whilst carrying out a post operational check, you notice a fault, what do you do before leaving the forklift?

---

---

---

---

# ATTACHMENT A

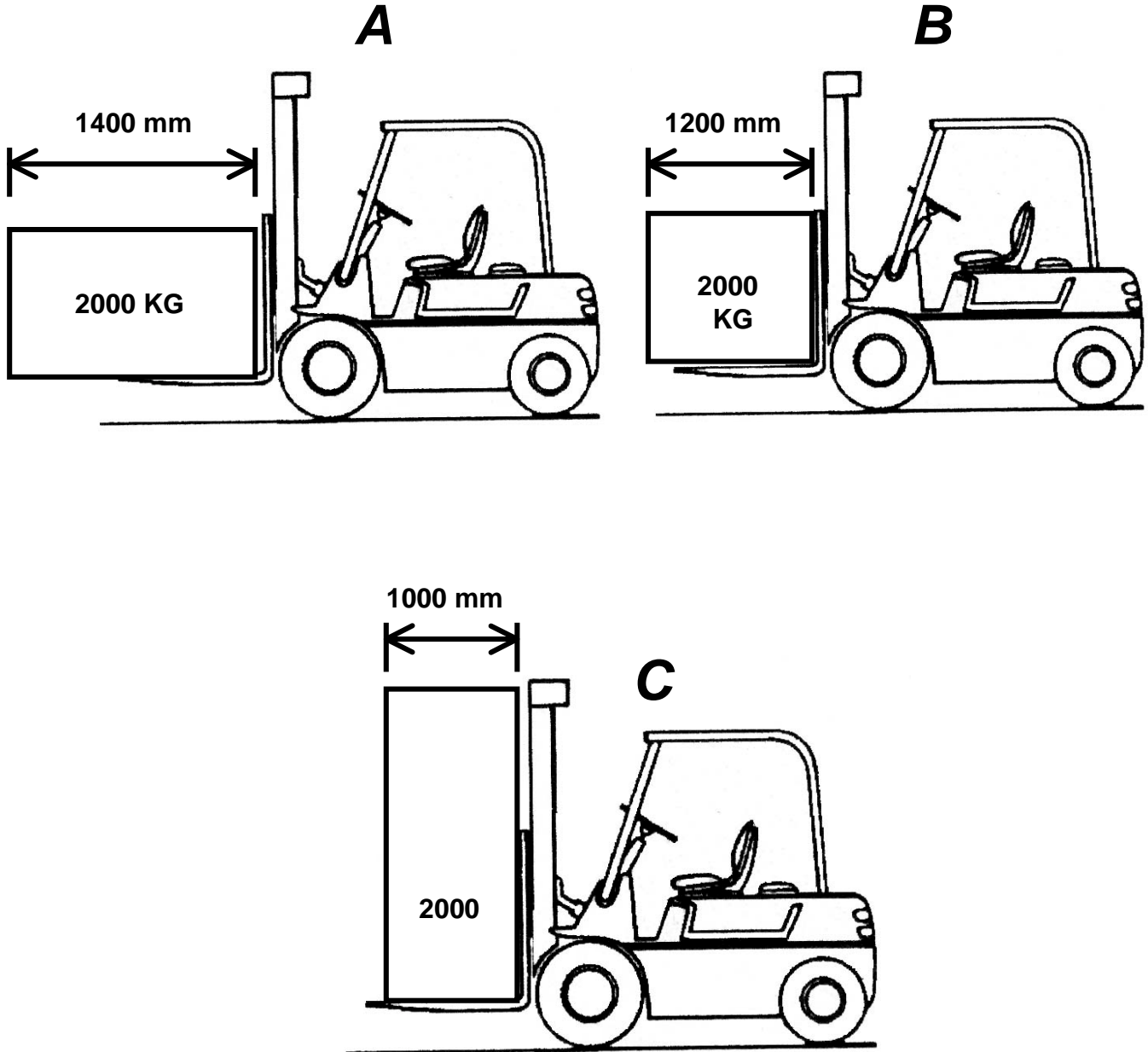

# ATTACHMENT B

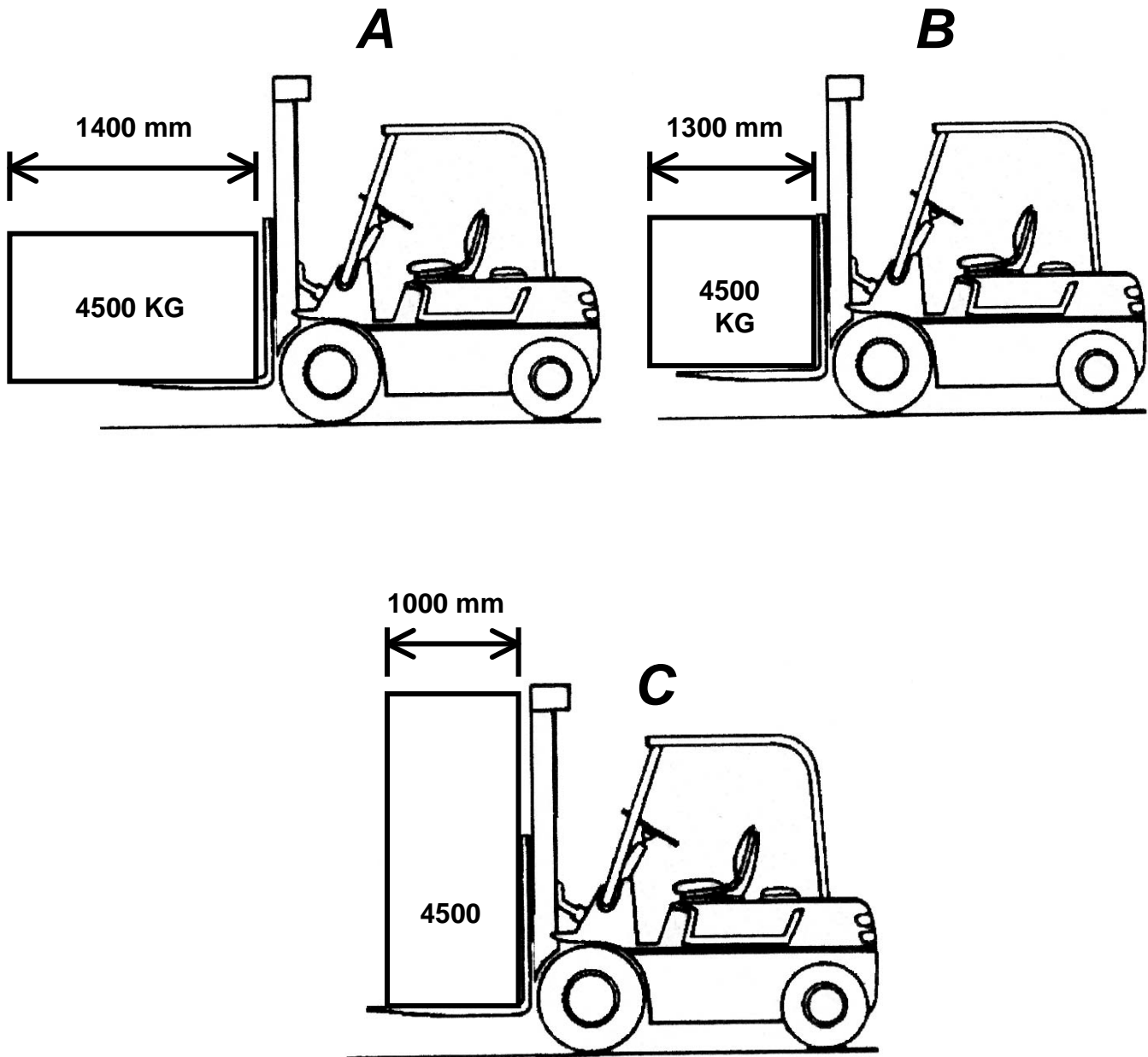

# MODEL ORAL/WRITTEN

## ANSWERS

1.
  - Hydraulic oil
  - Engine oil
  - Transmission oil
  - Brake fluid
  - Cooling water
  - Fuel
  - Battery electrolyte level in each cell
2.
  - Brakes
  - Steering
  - Controls
  - Lights
  - Warning devices
  - Tyres
  - Attachments
  - Security of attachments
3. **Isolate fuel supply if possible. The machine should be immediately stopped, the leak reported to an authorised person and an appropriate warning notice placed on the forklift, indicating forklift must not be used.**
4. Report it to an authorised person and place a warning notice on the forklift indicating forklift must not be used.
5. **Report it to an authorised person and place a warning notice on the forklift indicating forklift must not be used.**
6. Only if the operator was a competent person and was authorised by the employer.
7. No, it must be reported to an authorised person and a warning notice placed on the forklift indicating forklift must not be used.
8. Immediately.
9. A load backrest stops the load from fouling the mast and prevents load falling onto the operator.
10.
  - Overhead guard
  - Load backrest
11. **No. The running engine could ignite the fuel.**
12. **The forklift must travel up the ramp forwards, therefore the load must face uphill.**
13. To ensure stability is maintained and to prevent load from falling off the fork arms.
14. **The forklift must travel down in reverse, therefore the load must face uphill.**
15. **Because lateral stability is affected and the forklift could overturn or the load could slide.**
16. **Lateral stability is affected and the forklift truck could tip over sideways.**
17. At an angle of 45 degrees and at a slow speed. Ramps or bridging plates should be used if instability is likely to occur.
18. **Approximately axle height or a reasonable minimum distance from the operating surface.**
19.
  - Surface condition.
  - Physical layout of work area.
  - Potential hazards.
  - The size of the load to be moved.
  - Proximity to pedestrians.
  - Weather conditions.
  - Speed limit signs
  - Workplace policy

20. **The heavier end of the load must always be against the heel of the forks.**
21. The load should not be lifted. The load should be removed and re-stacked on an undamaged pallet.
22. Bagged goods should be transported and stored on pallets. Bags should be cross stacked and stepped (pyramid shaped) above 1.5 metres.
23. **At least 2 metres from domestic powerlines and at least 6 metres from high voltage transmission lines.**

**Note: Assessor must ensure that applicant is aware of Statutory Authority regulations.**

- 24.
- Warn other people to stay clear and not to touch the forklift.
  - Try and break contact with powerlines by moving forklift if possible.
  - Remain in or on the forklift until informed that conditions are safe.
  - If you must leave the forklift, jump clear ensuring that you don't contact the forklift and the ground at the same time.
25. **Persons in the confined spaces could be overcome by dangerous gas generated by the combustion engine.**
26. A battery powered forklift truck.
27. To reduce the risk of a build up of explosive gases.
28. **The gases given off by the batteries will explode if ignited.**
29. Four wheel drive or rough terrain type forklift truck.

30. It is the distance from the ground to the top of the mast when the fork arms are at their lowest position.
31. It is the distance from the ground to the top of the load backrest when the mast is fully raised.
32. Travel in reverse or use another person to guide you.
33. **Barriers with appropriate safety signs, or alternatively a flag person present at all times.**
34. **Post signs, place barriers, control movement of personnel, use of lights and horns.**
35. **The rapid sideways movement at the rear of the forklift truck creates a hazard, particularly for pedestrians near by.**
36. To ensure safety control measures are in place and are followed before operating.
37. No. The fork arm carrying the load may be over stressed and the lateral stability of the forklift truck will be seriously affected.
38. No, unless advised otherwise by the manufacturer, the existing counterweights have been designed for the maximum Safe Working Load of the forklift truck,
39. Reduce speed and proceed with caution. Turn corners slowly and drive in a manner consistent with operating surface.
40. **The attachment must be an appropriate type suitable for the forklift truck and the load to be lifted. Must be properly attached to the forklift with a suitable locking device. Data plate must allow for the use of the attachment.**

41. Familiarise yourself with the equipment before starting work, and if necessary undergo additional training with an experienced person.
- 42.
- Travel at low speed and make all turns slowly.
  - Load must be kept as low to the ground as possible.
  - Jib must be kept as low as possible and not tilted forward past the vertical.
  - Treat forklift as if it is partially loaded at all times, even when no load is on the jib.
43. No, the mast must be vertical or on back tilt at all times.
44. Safe Working Load. (SWL)
45. The operator must be aware of the protruding length of the spike and that longitudinal stability and load capacity are significantly reduced. Particular care must be taken when turning.
46. The forklift truck will be unstable if the centre of gravity of the load is off to one side.
47. No. Forklift stability can be affected. Rotation of the load should only take place when the forklift is stationary.
48. With a drum clamp or on a pallet.
49. Both must have equal lifting capacity or Safe Working Load.
50. Able to swivel.
51. To ensure the forklift trucks stability is not affected and to prevent the load from swinging on lift.
52. Prior to their use. AS 1666.1
53. Stretched wire, affected by heat, rust, crushing, acid attack, damaged eye splicing, illegible tags or missing tags or birdcaging and more that 10% of wires broken within a length of 8 times the diameter of the wire rope.
- 54.
- By colour coding to Australian Standards.
  - By label or tag attached to sling.
55. To prevent it unscrewing.
56. 10% wear.
57. By the metal tag attached to the upper terminal link or sling immediately adjacent to it or calculate using the appropriate formula.
58. **No, not under any circumstances, loads must never be raised or passed over people, it is against safe operating procedures**
59. An approved seat and footrest.
60. **No, it is against regulations**
61. **By use of a correctly secured Safety Cage (Forklift Truck Work Platform).**
- Note:** Some states require mandatory Design Approval/ Registration of Work Platforms, check with relevant Statutory Authority for requirements.
62. Travel controls must be in neutral. Parking brake must be engaged.
63. Operator must remain at the forklift controls at all times.
64. **No, not under any circumstances.**
65. The emergency isolator.
66. To Identify damage, prevent accidents and to ensure safe operation of forklift truck.

67. Report it to an authorised person.
68. A flat or an under inflated tyre can cause the forklift truck to tip over.
- 69.
- Only experienced operators to be used
  - The operation must be controlled by a third person who is responsible and experienced.
  - The load applied to each forklift truck must be no more than 75% of its rated capacity, taking account of stability, load-centre distance and any other factors which may affect the forklift truck SWL.
  - The distance travelled shall be limited to clearing the load carrier.
70. By the forklift data plate and by information provided by your employer and documented by the manufacturer.
71. It is the maximum load that a forklift truck is designed to carry at a specified load elevation at a specific load centre distance.
72. **The distance measured from the vertical face of the forks to the loads centre of gravity.**
73. **Reduces the forklift truck capacity.**
74. The forklift trucks capacity will be reduced and stability may be affected.
75. **Where a line drawn vertically, passing through the centre of the front axle, meets the ground.**
76. Yes
77. Load A
78. Load C
- 79.
- (i) To ensure load is within forklift truck lifting capacity.
  - (ii) To prevent accidents and avoid damage.
  - (iii) To stop overloading.
80. **By calculation, consignment notes or weighbridge certificates etc.**
81. 213Kg.
82. 1000kg.
- 83.
- Loads should be stacked on a firm level site.
  - Heavy goods must be placed at the bottom.
  - Stack should not become unstable due to height.
84. Only when required to place fork arms under loads or out from beneath loads just placed in position, or when placing a load on a stack and when parking a machine fitted with forks.
85. Restack it so it is safe.
- 86.
- **Turning at speed.**
  - **Driving over uneven surfaces.**
  - **Unevenly distributed load.**
  - **Driving with a flat, or under inflated tyre.**
  - **Driving too fast. (loaded or unloaded)**
  - **Turning with the load raised.**
  - **Braking too hard when cornering.**
  - **Side shift not centred.**

- 87.
- **Overloading.**
  - **Severe braking.**
  - **Incorrect use of the mast tilt. (especially with the load carried at a high level)**
  - **Load not positioned against the heel of the fork arms.**
  - **Shifting of the load centre forward. ( centre of load is forward of the approved load centre)**
  - **Operating on sloping surface.**
88. Secured dockplates or bridgeplates.
89. All emergency vehicles.
- 90.
- **Near First Aid Stations.**
  - **Near fire fighting appliances.**
  - **Near doorways.**
  - **On sloping surfaces.**
  - **On or near pedestrian walkways.**
  - **Emergency exits.**
  - **Where it is obstructing other traffic.**
  - **At a distance NOT less than 2 metres to the nearest rail of a rail track.**
91. The doorway may need to be used in an emergency.
92. In addition to normal parking procedures, chock the wheels of the forklift.
93. Fork arms must be lowered so that the fork arms are resting flat on the supporting surface.
94. To reduce the risk of explosion caused by leaking LPG.
- 95.
- To detect structural damage.
  - To ensure all systems are closed off.
  - To detect leaks in oil / hydraulic lines.
  - To ensure forklift is ready for next operator.
96. Remove the keys and place a warning notice on the forklift indicating the forklift must not be used, and then report the fault to an authorised person.
97. To prevent unauthorised movement of the forklift truck.



**ORAL/WRITTEN ASSESSMENT**

OPERAT- IONAL AREA UNIT	Number of critical criteria required	Number of critical criteria achieved	Number of non- critical criteria required	Number of non- critical criteria achieved
<b>1</b>	<b>20</b>	<input type="text"/>	<b>11</b>	<input type="text"/>
<b>2</b>	<b>9</b>	<input type="text"/>	<b>3</b>	<input type="text"/>
<b>3</b>	<b>1</b>	<input type="text"/>	<b>3</b>	<input type="text"/>
Assessment start time:		: am/pm	Finish time:	
			: am/pm	
Oral/Written Assessment completed within time allowed – 1.5hour?				

Competent? (tick)	
YES	NO
<input type="checkbox"/>	<input type="checkbox"/>
<input type="checkbox"/>	<input type="checkbox"/>
<input type="checkbox"/>	<input type="checkbox"/>
<input type="checkbox"/>	<input type="checkbox"/>

**PERFORMANCE ASSESSMENT**

OPERAT- IONAL AREA UNIT	Number of criteria required	Number of criteria achieved
<b>1</b>	<b>3</b>	<input type="text"/>
<b>2</b>	<b>1</b>	<input type="text"/>
<b>3</b>	<b>2</b>	<input type="text"/>
Assessment Start time:		: am/pm
Assessment Finish time:		: am/pm
Performance Assessment completed within time allowed – 1 hour?		

Competent? (tick)	
YES	NO
<input type="checkbox"/>	<input type="checkbox"/>
<input type="checkbox"/>	<input type="checkbox"/>
<input type="checkbox"/>	<input type="checkbox"/>
<input type="checkbox"/>	<input type="checkbox"/>

**Applicant is:**

**COMPETENT**

(tick or circle the result obtained)

**NOT YET COMPETENT**

**Name of Assessor:**.....

**Name of Applicant:**.....

**Signature:**.....

**Signature:**.....

**Date:** ..../..../....

**Comments/Feedback** (Assessor to make additional comments which clarify the assessment results)

-----

-----

-----

-----

-----

-----

-----

-----

-----

-----